

A

Einspeisung
Alimentation
Power supply

Der Schutz der Anlage entspricht den geltenden Normen.
Protection de l'installation conforme aux normes en vigueur.
Protection of the installation in conformity with the actual norms.

Erdung nach örtlichen Vorschriften!
Mise à la terre conformément au réseau local!
Earthing in accordance with local regulation!

- Hauptklemmleiste
Bornier principal
Main terminals
- Interne Klemmleiste
Bornier interne
Internal terminals

B

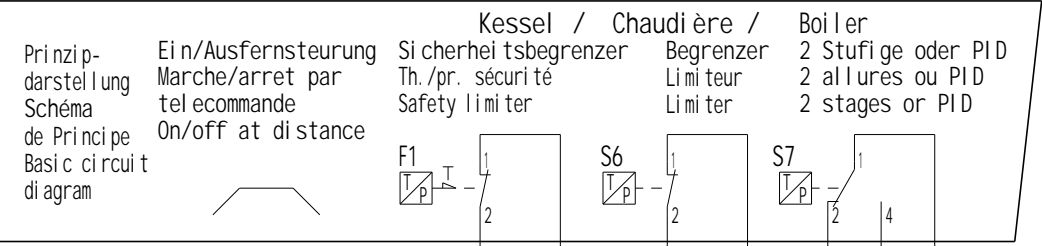
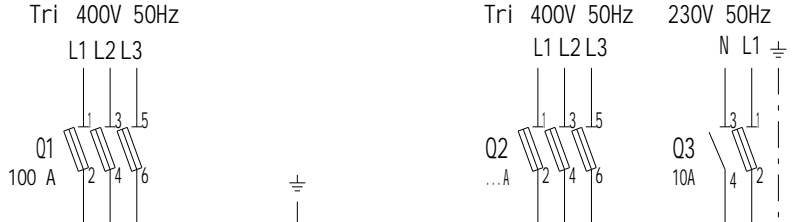

C

Schaltschrank
Armoire
Control cabinet

Steuerung
Fusible de commande
Control fuse

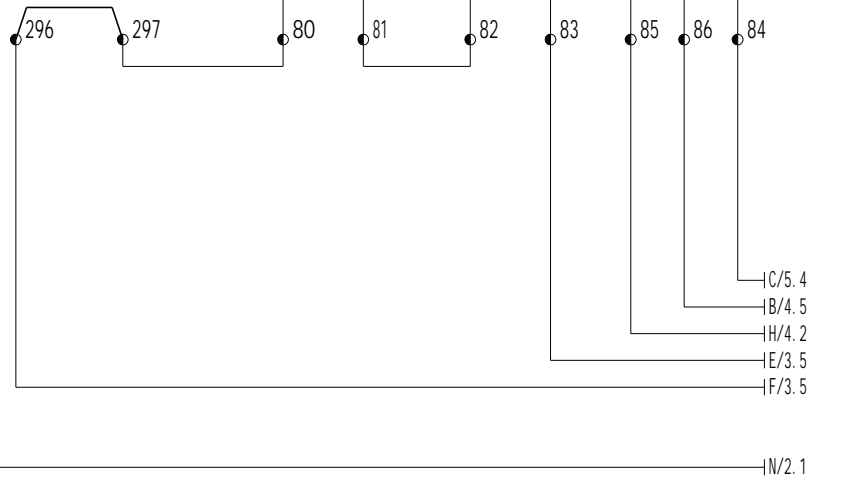
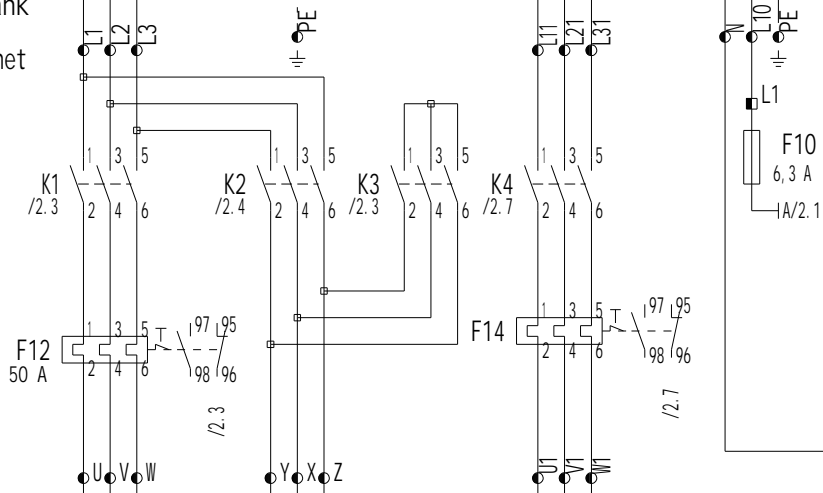

D

E

Brenner
Brûleur
Burner
Brennermotor
Moteur de ventilation
Fan motor

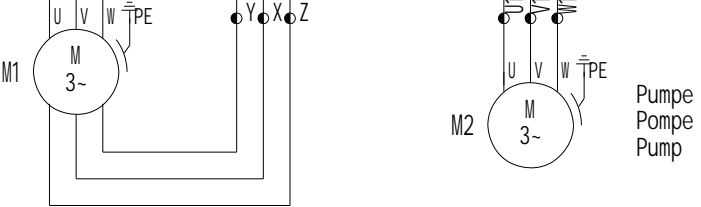

Aend. /Modificati on	Dat.	Vis.	gez. dess.	Dat.	Vis.
AM 9309	30.08.00	Pru		22.10.98	
			gepr. contr.	22.10.98	



Art. N°:	13002441-E	Type	CC501/CC503 B 617/8	Blatt/Page	1
Bez. /Des. 1	Schéma électrique	Schema Draw.	GL03. 1. 0023	Tot. Bl /Pg	6
Bez. /Des. 2	Brûleur mixte				

S1
Service Switch
Ein-Aus
Interrupt de
service
Service switch
on-off

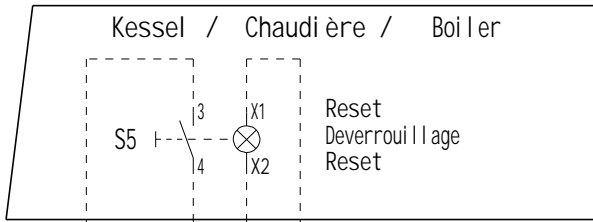

Armoire

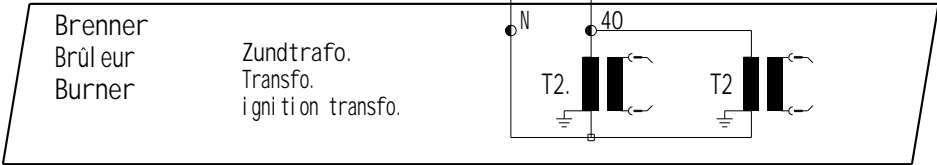
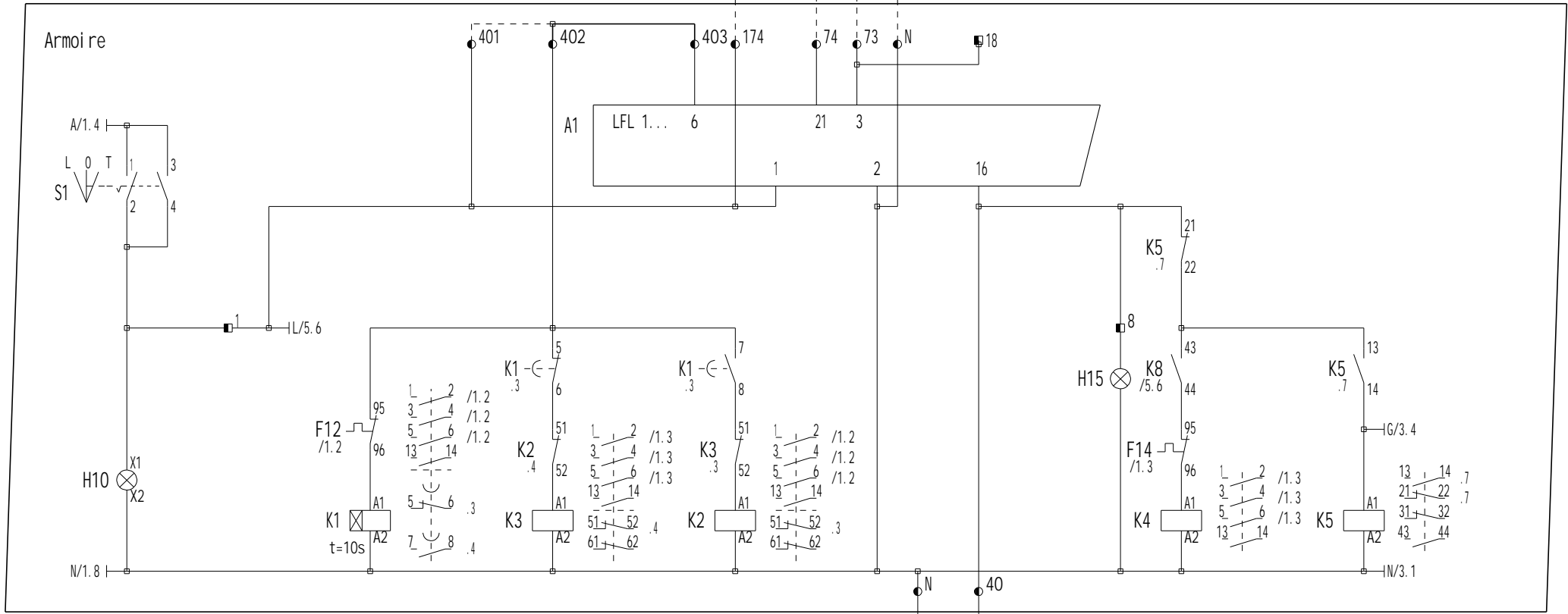

e	Aend. /Modificati on	Dat.	Vis.	Dat.	Vis.
f	AM 9309	30.08.00	Pru	22.10.98	
g				22.10.98	
h					



Art. N°:	13002441-E	Type	CC501/CC503 B 617/8	Blatt/Page	2
Bez. /Des. 1	Schéma électrique	Schema Draw.	GL03. 1. 0023	Tot. Bl /Pg	6
Bez. /Des. 2	Bruleur mixte				

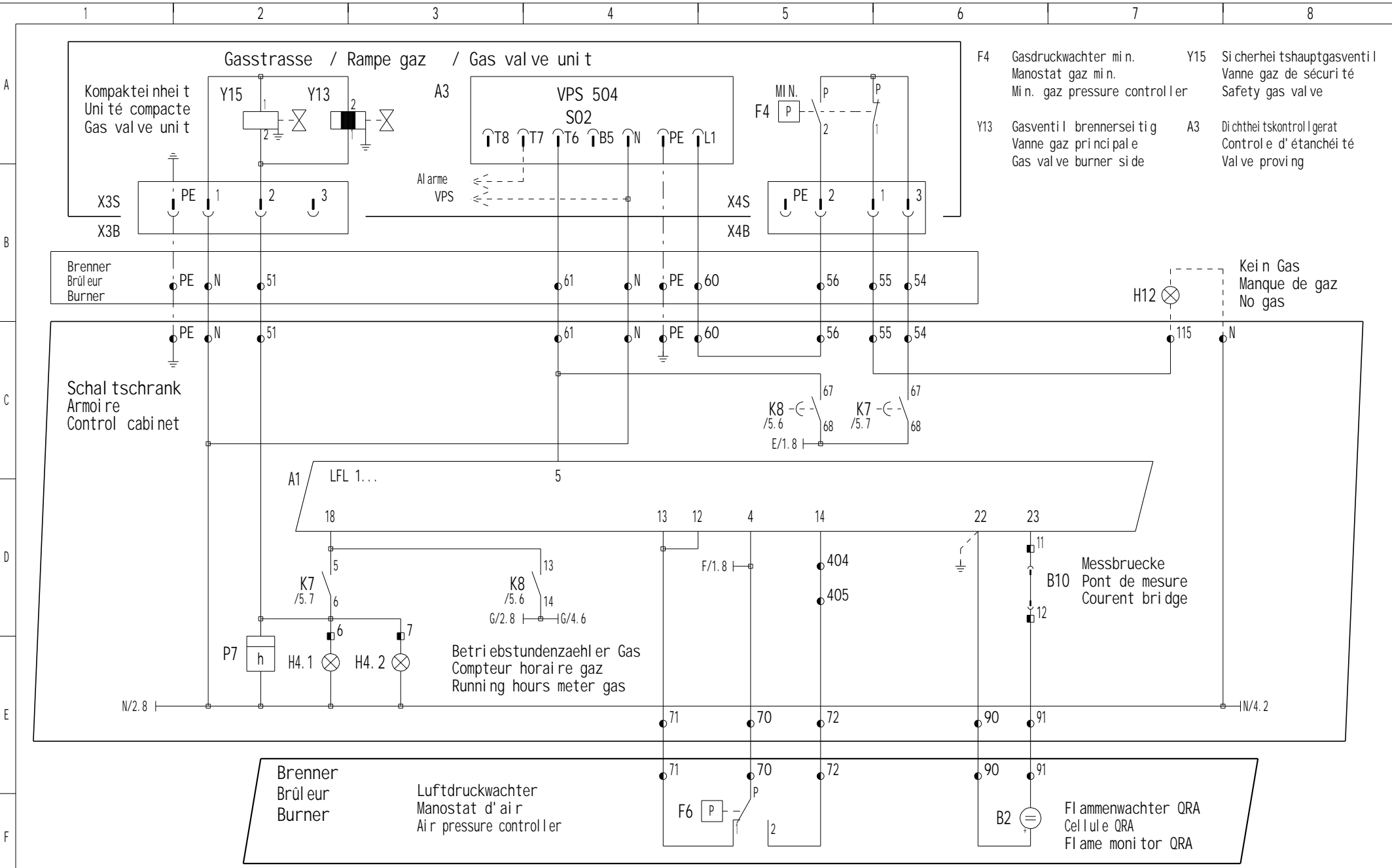

- F4 Gasdruckwächter min. Manostat gaz min. Min. gaz pressure controller
- Y15 Si cherhe tshauptgasventil Vanne gaz de sécurité Safety gas valve
- Y13 Gasventil brennerseitig Vanne gaz principale Gas valve burner side
- A3 Dichtheitskontrollgerät Contrôle d'étanchéité Valve proving

Aend. /Modificati on	Dat.	Vis.	gez.	Dat.	Vis.
AM 9309	30.08.00	Pru	dess.	22.10.98	
			gepr.	22.10.98	
			contr.		



Art. N°:	13002441-E	Type	CC501/CC503 B 617/8	Blatt/Page	3
Bez. /Des. 1	Schéma électrique	Schema Draw.	GL03. 1. 0023	Tot. Bl /Pg	6
Bez. /Des. 2	Bruleur mixte				

	Y1	Y2	Y5
I	1	0	0
II	1	1	0
III	1	1	1

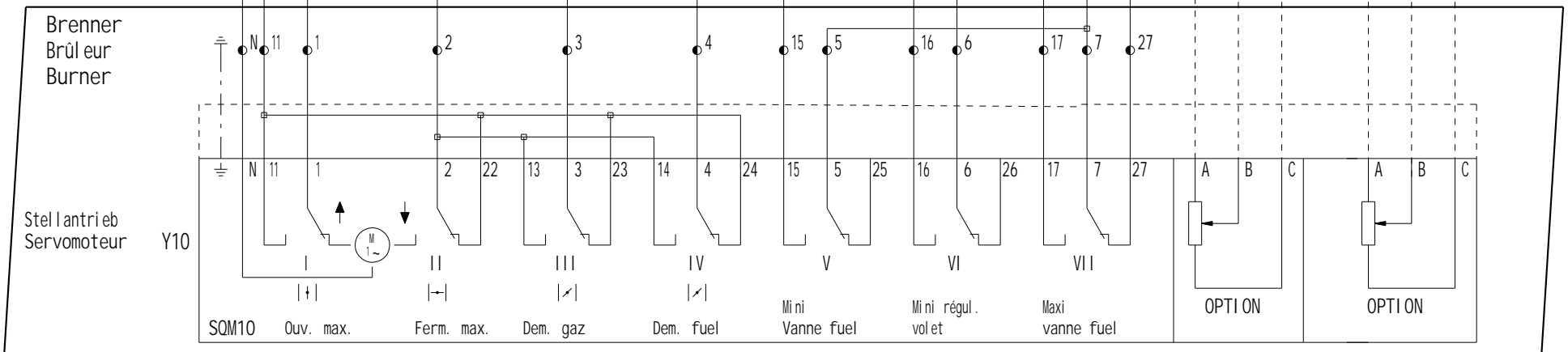
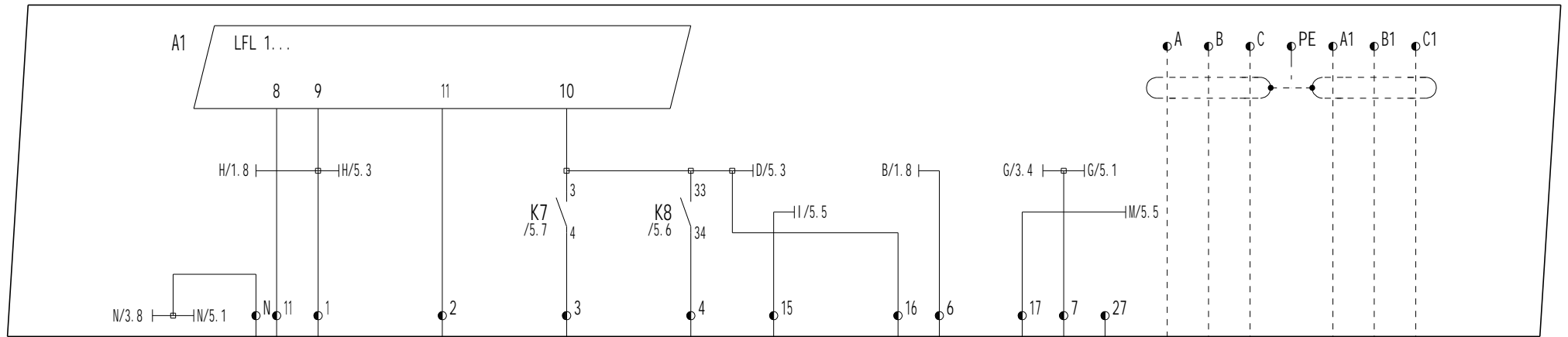

	Aend. /Modifi cation	Dat.	Vis.	Dat.	Vis.
e	AM 9309	30.08.00	Pru		
f			gez.	22.10.98	
g			dess.		
h			gepr.	22.10.98	
			contr.		



Art. N°:	13002441-E	Type	CC501/CC503 B 617/8	Blatt/Page	4
Bez. /Des. 1	Schema elctrique	Schema Draw.	GL03. 1. 0023	Tot. Bl /Pg	6
Bez. /Des. 2	Bruleur mixte				

A

B

C

D

E

F

Ferngesteuerter Brennstoffwahl
 Choix combustible par telecommande
 Fuel choice at distance
 Regler/Régulation/regulation
 Gerber/Sondes/Sensors

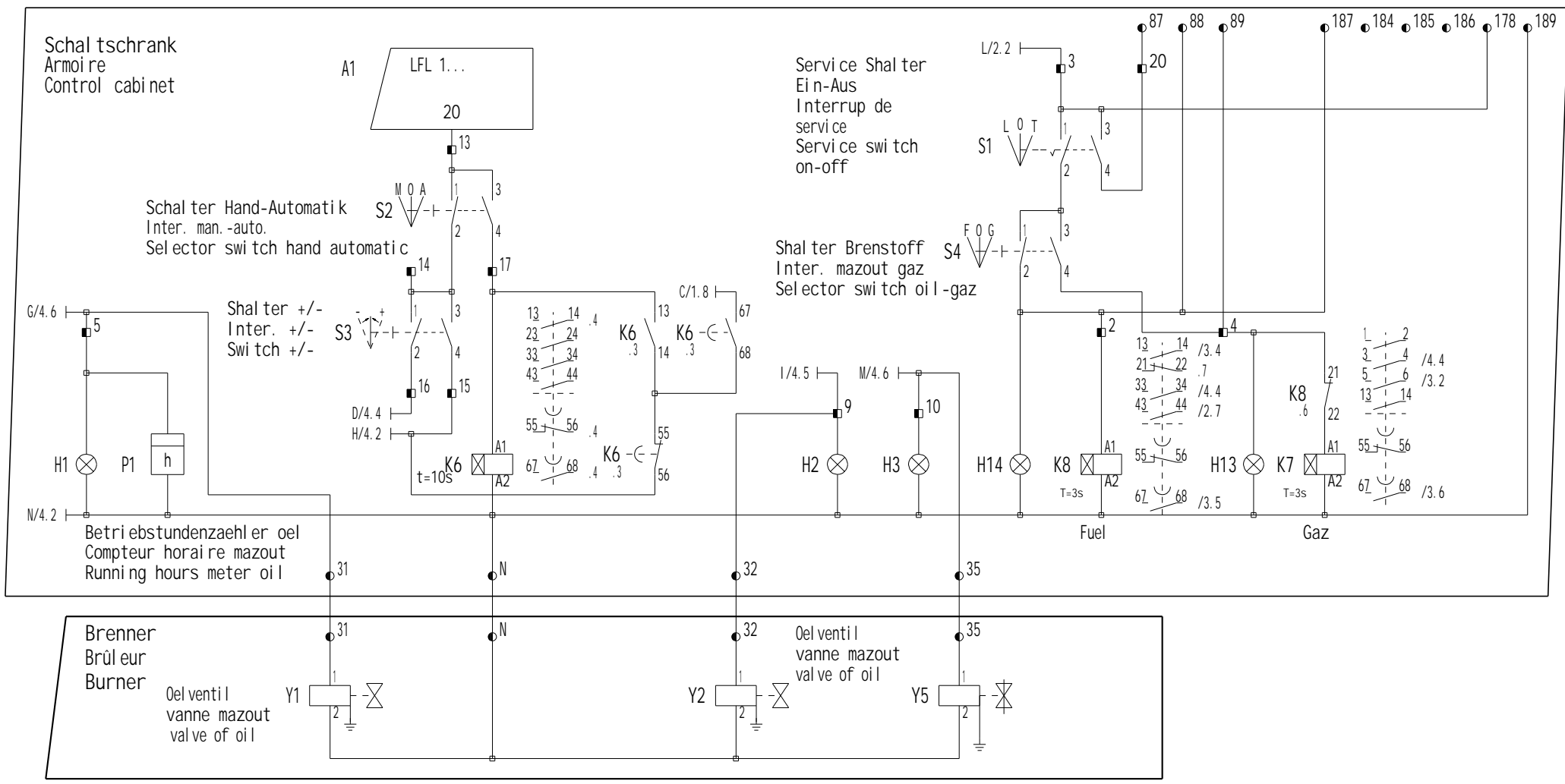

Aend. /Modificati on	Dat.	Vis.	gez. /dess.	Dat.	Vis.
AM 9309	30.08.00	Pru		22.10.98	
			gepr. /contr.	22.10.98	



Art. N°:	13002441-E	Type	CC501/CC503 B 617/8	Blatt/Page	5
Bez. /Des. 1	Schema electrique	Schema Draw.	GL03. 1. 0023	Tot. Bl /Pg	6
Bez. /Des. 2	Brûleur mixte				

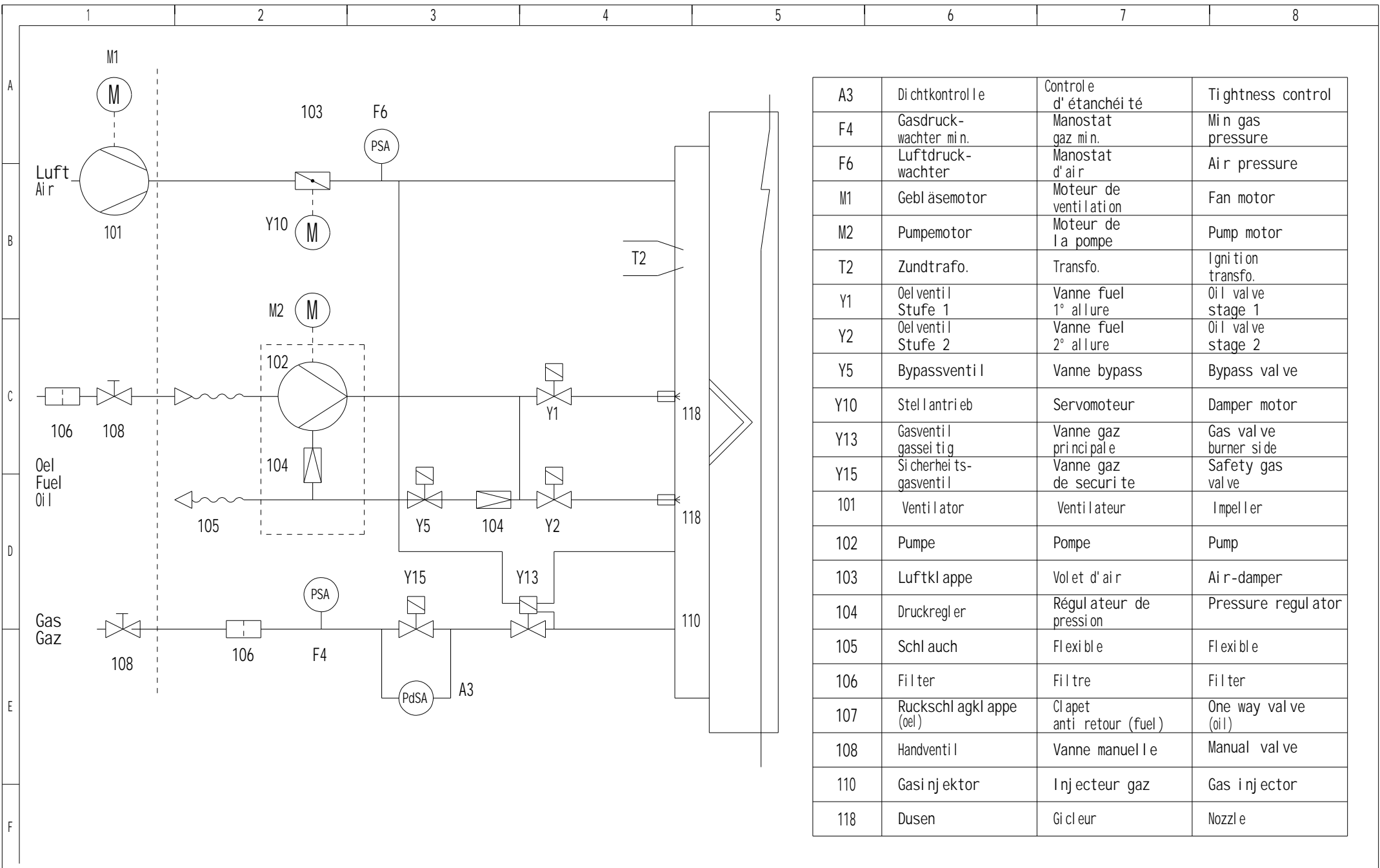

A3	Dichtkontrolle	Contrôle d'étanchéité	Tightness control
F4	Gasdruckwächter min.	Manostat gaz min.	Min gas pressure
F6	Luftdruckwächter	Manostat d'air	Air pressure
M1	Gebäsemotor	Moteur de ventilation	Fan motor
M2	Pumpemotor	Moteur de la pompe	Pump motor
T2	Zundtrafo.	Transfo.	Ignition transfo.
Y1	Ölventil Stufe 1	Vanne fuel 1° allure	Oil valve stage 1
Y2	Ölventil Stufe 2	Vanne fuel 2° allure	Oil valve stage 2
Y5	Bypassventil	Vanne bypass	Bypass valve
Y10	Stellantrieb	Servomoteur	Damper motor
Y13	Gasventil gasseitig	Vanne gaz principale	Gas valve burner side
Y15	Sicherheitsgasventil	Vanne gaz de sécurité	Safety gas valve
101	Ventilator	Ventilateur	Impeller
102	Pumpe	Pompe	Pump
103	Luftklappe	Volet d'air	Air-damper
104	Druckregler	Régulateur de pression	Pressure regulator
105	Schlauch	Flexible	Flexible
106	Filter	Filtre	Filter
107	Rückschlagklappe (öl)	Clapet anti retour (fuel)	One way valve (oil)
108	Handventil	Vanne manuelle	Manual valve
110	Gasinjektor	Injecteur gaz	Gas injector
118	Dusen	Gicleur	Nozzle

e	Aend. /Modificati on	Dat.	Vis.		Dat.	Vis.
f	AM 9309	30.08.00	Pru	gez.	22.10.98	
g				dess.		
h				gepr.	22.10.98	
				contr.		



Art. N°:	13002441-E	Type	CC501/CC503 B 617/8	Blatt/Page	6
Bez. /Des. 1	Schéma hydraulique	Schema Draw.	GL03. 1. 0023	Tot. Bl /Pg	6
Bez. /Des. 2	Bruleur mixte				