

Ein/Ausfernsteuerung
 Marche/arret par
 telecommande
 On/off at distance

Kessel / Chaudière / Boiler

S5
 X1
 X2
 Reset
 Déverrouillage
 Reset

Post ventil - Nachspülung

Schaltschrank
 Armoire
 Control cabinet

Brenner
 Brûleur
 Burner

A1
 LFL 1... 6 7
 1 21 3
 2 16

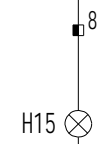
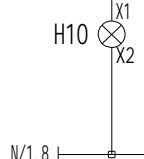
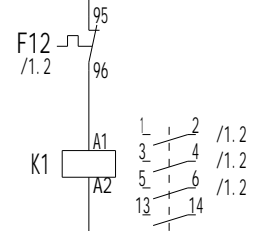
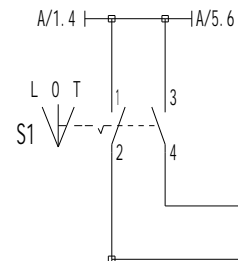

Service Schalter Ein-Aus
 Interrupteur de service
 Service switch on-off

Zundtrafo.
 Transfo.
 Ignition transfo.

	Aend. /Modificati on	Dat.	Vis.	gez.	Dat.	Vis.
a	AM 8522	24.06.96	Pru	gez.	08.12.97	cod
b	AM 8780	08.12.97	Pru	dess.		
c	AM 9364	02.11.00	Pru	gepr.	08.12.97	dl
d				contr.		



Art. N°:	13001140-C	Type	CC 501 G507/8	Blatt/Page	2
Bez. /Des. 1	Schéma électrique	Schema Draw.	G03.1.0066	Tot. Bl /Pg	6
Bez. /Des. 2	Brûleur gaz				

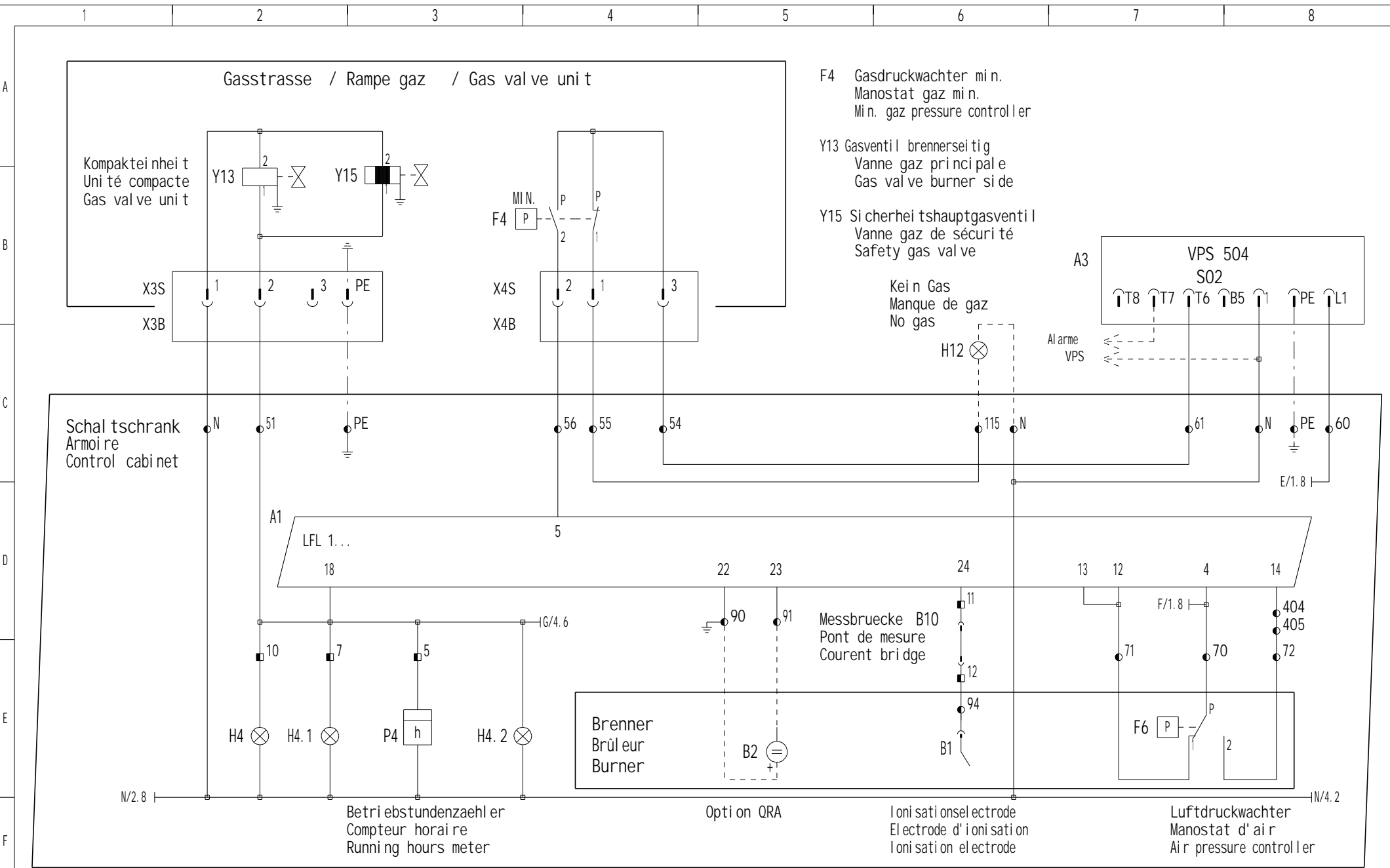

F4 Gasdruckwächter min.
Manostat gaz min.
Min. gas pressure controller

Y13 Gasventil brennerseitig
Vanne gaz principale
Gas valve burner side

Y15 Sicherheitshauptgasventil
Vanne gaz de sécurité
Safety gas valve

Aend. /Modifications	Dat.	Vis.	gez.	Dat.	Vis.
a AM 8522	24.06.96	Pru	gez.	08.12.97	cod
b AM 8780	08.12.97	Pru	dess.		
c AM 9364	02.11.00	Pru	gepr.	08.12.97	dl
d			contr.		



Art. N°:	13001140-C	Type	CC 501 G507/8	Blatt/Page	3
Bez. /Des. 1	Schéma électrique	Schema Draw.	G03.1.0066	Tot. Bl /Pg	6
Bez. /Des. 2	Brûleur gaz				

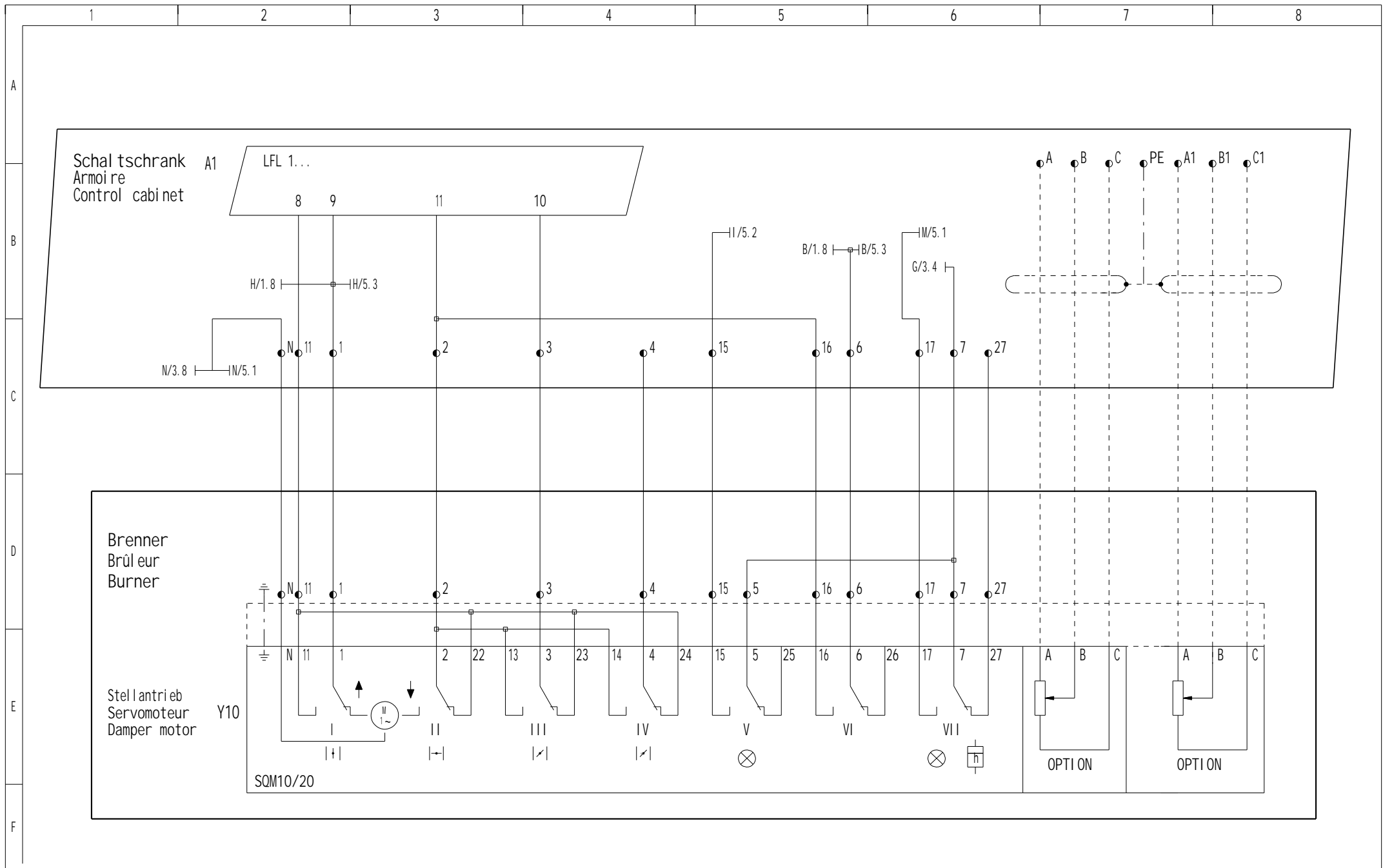

	Aend. /Modifi cation	Dat.	Vis.	Dat.	Vis.
a	AM 8522	24.06.96	Pru	08.12.97	cod
b	AM 8780	08.12.97	Pru	08.12.97	cod
c	AM 9364	02.11.00	Pru	08.12.97	dl
d					



Art. N°:	13001140-C	Type	CC 501 G507/8	Blatt/Page	4
Bez. /Des. 1	Schéma él ectri que	Schema Draw.	G03.1.0066	Tot. Bl /Pg	6
Bez. /Des. 2	Brul eur gaz				

A

Regler/Régulation/regulation

Gerber / Sondes / Sensors

B

Schaltschrank
Armoire
Control cabinet

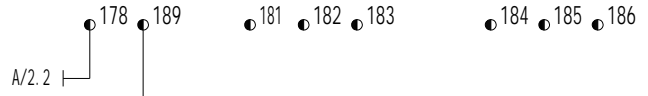
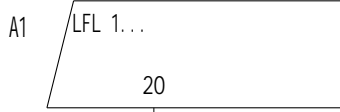

S2 M O A
Schalter Hand-Automatik
Inter. man.-auto.
Selector switch hand automatic

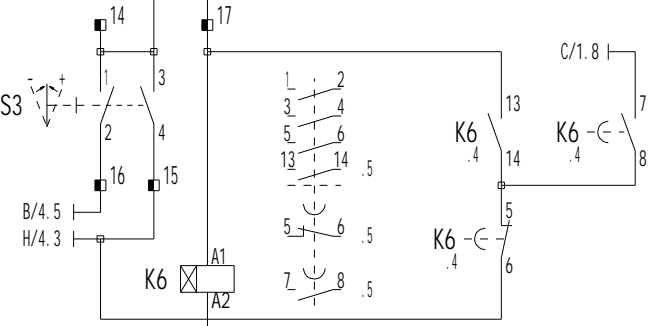
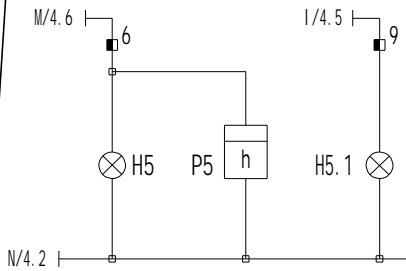

Betriebsstundenzähler
Compteur horaire
Running hours meter

E

F

	Aend. /Modificati on	Dat.	Vis.	gez.	Dat.	Vis.
a	AM 8522	24.06.96	Pru	gez.	08.12.97	cod
b	AM 8780	08.12.97	Pru	dess.		
c	AM 9364	02.11.00	Pru	gepr.	08.12.97	dl
d				contr.		



Art. N°:	13001140-C	Type	CC 501 G507/8	Blatt/Page	5
Bez. /Des. 1	Schéma électrique	Schema Draw.	G03.1.0066	Tot. Bl /Pg	6
Bez. /Des. 2	Bruleur gaz				

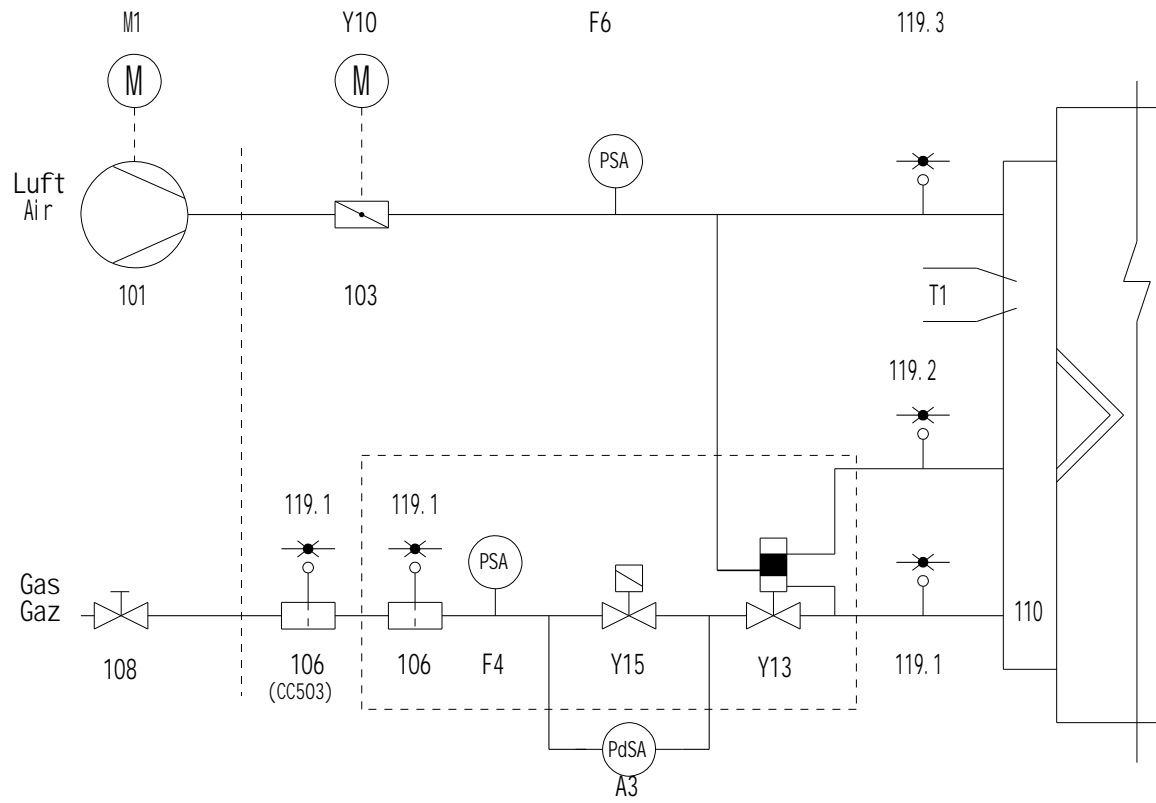

A3	Dichtkontrolle	Controle d'étanchéité	Tightness control
F4	Gasdruckwächter min.	Manostat gaz min.	Min gas pressure
F6	Luftdruckwächter	Manostat d'air	Air pressure
M1	Gebläsemotor	Moteur de ventilation	Fan motor
T2	Zundtrafo.	Transfo.	Ignition transfo.
Y10	Stellantrieb	Servomoteur	Damper motor
Y13	Gasventil gaseutig	Vanne gaz principale	Gas valve burner side
Y15	Sicherheitsgasventil	Vanne gaz de securite	Safety gas valve
101	Ventilator	Ventilateur	Impeller
103	Luftklappe	Volet d'air	Air-damper
106	Filter	Filtre	Filter
108	Handventil	Vanne manuelle	Manual valve
110	Gasinjektor	Injecteur gaz	Gas injector
114	Mikroschalter	Micro contact	Microswitch
119.1	Messniessel Gas	Pression gaz	Pressure pickup Gas
119.2	Messniessel Feuerraum	Pression foyer	Pressure pickup furnace
119.3	Messniessel Luft	Pression air	Pressure pickup air

	Aend./Modifikation	Dat.	Vis.	gez.	Dat.	Vis.
a	AM 8522	24.06.96	Pru	gez.	08.12.97	cod
b	AM 8780	08.12.97	Pru	dess.		
c	AM 9364	02.11.00	Pru	gepr.	08.12.97	dl
d				contr.		



Art. N°:	13001140-C	Type	CC 501 G507/8	Blatt/Page	6
Bez./Des. 1	Schéma hydraulique	Schema Draw.	G03.1.0066	Tot. Bl./Pg	6
Bez./Des. 2	Bruleur gaz				